

ME 130 Applied Engineering Analysis

Chapter 5

Review of Laplace Transform and Its Applications in Mechanical Engineering Analysis

(CONDENSED VERSION)

**Tai-Ran Hsu, Professor
Department of Mechanical Engineering
San Jose State University
San Jose, California, USA**

Chapter Learning Objectives

- To learn the application of Laplace transform in engineering analysis
- To learn the **required conditions** to transform variable or variables in functions by Laplace transform
- To learn the use of available Laplace transform table for transformation of functions and the inverse transformation
- To learn to use partial fraction and convolution methods in inverse Laplace transforms
- To learn the Laplace transform for ordinary derivatives and partial derivatives of different orders
- To learn how to use Laplace transform method to solve ordinary differential equations

Laplace Transform in Engineering Analysis

- Laplace transforms is a mathematical operation that is used to “transform” a variable (such as x , or y , or z , or t) to a parameter (s)- transform ONE variable at time. Mathematically, it can be expressed as:

$$L_t[f(t)] = \int_0^{\infty} e^{-st} f(t)dt = F(s) \quad (5.1)$$

where $F(s)$ = expression of Laplace transform of function $f(t)$ involving parameter s

- In a layman’s term, Laplace transform is used to “transform” a variable in a function into a **parameter**
- So, after the transformation that variable is no longer a variable anymore, but should be treated as a “**parameter**”, i.e a “**constant under a specific condition**”
- This “specific condition” for Laplace transform is:
 - *Laplace transform can only be used to transform variables that cover a range from “zero (0)” to infinity, (∞), for instance: $0 < t < \infty$*
 - *Any variable that does not vary within this range cannot be transformed using Laplace transform*
- Because time variable t is the most common variable that varies from (0 to ∞), functions with variable t are commonly transformed by Laplace transform
- Laplace transform is a valuable “tool” in solving:
 - Differential equations for example: electronic circuit equations, and
 - In “feedback control” for example, in stability and control of aircraft systems

Laplace transform of simple functions:

For $f(t) = t^2$ with $0 < t < \infty$:

$$L[f(t)] = \int_0^{\infty} e^{-st} (t^2) dt = e^{-st} \left[-\frac{2t^2}{2s} - \frac{2t}{s^2} - \frac{2}{s^3} \right] \Big|_0^{\infty} = \frac{2}{s^3} = F(s) \quad (a)$$

For $f(t) = e^{at}$ with $a = \text{constant}$ and $0 < t < \infty$:

$$L[f(t)] = \int_0^{\infty} e^{-st} (e^{at}) dt = \int_0^{\infty} e^{(-s+a)t} dt = \frac{1}{-s+a} e^{(-s+a)t} \Big|_0^{\infty} = \frac{1}{s-a} \quad (b)$$

For $f(t) = \text{Cos}\omega t$ with $\omega = \text{constant}$ and $0 < t < \infty$:

$$L[\text{Cos}\omega t] = \int_0^{\infty} e^{-st} (\text{Cos}\omega t) dt = \frac{e^{-st}}{(-s)^2 + \omega^2} (-s \text{Cos}\omega t + \omega \text{Sin}\omega t) \Big|_0^{\infty} = \frac{s}{s^2 + \omega^2} \quad (c)$$

Appendix 1 of the printed notes provides a [Table of Laplace transforms](#) of simple functions

For example, $L[f(t)]$ of [polynomial \$t^2\$](#) in Equation (a) is Case 3 with $n = 3$ in the Table, [exponential function \$e^{at}\$](#) in Equation (b) in Case 7, and [trigonometric function \$\text{Cos}\omega t\$](#) in Equation (c) in Case 18

Properties of Laplace Transform

Laplace transform of functions by integration:

is not always easy.
$$L_t[f(t)] = \int_0^\infty e^{-st} f(t) dt = F(s) \tag{5.1}$$

Laplace transform (LT) Table in Appendix 1 is useful, but does not always have the required answer for the specific functions

- Following properties will be useful in finding the Laplace transform for specific functions:

1. Linear operators:

$$L[a f(t) + b g(t)] = a L[f(t)] + b L[g(t)]$$

where a, b = constant coefficients

Example 5.4:

Find Laplace transform of function: $f(t) = 4t^2 - 3\cos t + 5e^{-t}$ with $0 < t < \infty$:

By using the linear operator, we may break up the transform into three individual transformations:

$$L(4t^2 - 3\cos t + 5e^{-t}) = 4L[t^2] - 3L[\cos t] + 5L[e^{-t}] = F(s)$$

Case 3 with n = 3
Case 18 with $\omega=1$
Case 7 with a = -1 from the LT Table

Hence

$$F(s) = \frac{8}{s^3} - \frac{3s}{s^2 + 1} + \frac{5}{s + 1}$$

Properties of Laplace Transform – Cont'd

2. Shifting property:

If the Laplace transform of a function, $f(t)$ is $L[f(t)] = F(s)$ by integration or from the Laplace Transform (LT) Table, then the Laplace transform of $G(t) = e^{at}f(t)$ can be obtained by the following relationship:

$$L[G(t)] = L[e^{at}f(t)] = F(s-a) \quad (5.6)$$

where a in the above formulation is the shifting factor, i.e. the parameter s in The transformed function $f(t)$ has been shifted to $(s-a)$

Example 5.5:

Perform the Laplace transform on function: $F(t) = e^{2t} \text{Sin}(at)$, where $a = \text{constant}$

We may use the Laplace transform integral to get the solution, or we could get the solution by using the LT Table with the shifting property:

Since we can find $L[f(t)] = L[\text{Sin } at] = \frac{a}{s^2 + a^2}$ (Case 17)

We may use the shifting property to get the Laplace transform of $F(t) = e^{2t} \text{Sin}(at)$, by

“shifting the parameter s by 2, or

$$L[F(t)] = L[e^{2t} \text{Sin } at] = \frac{a}{(s-2)^2 + a^2}$$

3. Change of scale property:

If we know $L[f(t)] = F(s)$ either from the LT Table, or by integral, we may find the Laplace transform of function $f(at)$ by the following expression:

$$L[f(at)] = \frac{1}{a} F\left(\frac{s}{a}\right) \quad (5.7)$$

where $a =$ scale factor for the change

Example 5.6:

Perform the Laplace transform of function $F(t) = \text{Sin}3t$.

Since we know the Laplace transform of $f(t) = \text{Sint}$ from the LP Table as:

$$L[f(t)] = L[\text{Sint}] = \frac{1}{s^2 + 1} = F(s)$$

We may find the Laplace transform of $F(t)$ using the Change scale property to be:

$$L[\text{Sin}3t] = \frac{1}{3} \frac{1}{\left(\frac{s}{3}\right)^2 + 1} = \frac{3}{s^2 + 9}$$

Inverse Laplace Transform

We define the Laplace transform of a function $f(t)$ to be:

From here $\xrightarrow{\text{Laplace transform}}$ to there

$$L_t[f(t)] = \int_0^{\infty} e^{-st} f(t) dt = F(s)$$

There are times we need to do:

$$L_t[f(t)] = \int_0^{\infty} e^{-st} f(t) dt = F(s)$$

to here $\xleftarrow{\text{Inverse Laplace transform}}$ From there

3 Ways to inverse Laplace transform:

- Use LP Table by looking at $F(s)$ in right column for corresponding $f(t)$ in middle column - chance of success is not very good
- Use [partial fraction method](#) for $F(s)$ = rational function (i.e. fraction functions involving polynomials), and
- The [convolution theorem](#) involving integrations

The Partial Fraction Method for Inverse Laplace Transform

- The expression of $F(s)$ to be inversed should be in partial fractions as:

$$F(s) = \frac{P(s)}{Q(s)}$$

where polynomial $P(s)$ is at least one order less than the order of polynomial $Q(s)$

- “Break” up the above rational function into summation of “simple fractions” with which the corresponding inverse Laplace transforms can be obtained from the LT Tables:

$$F(s) = \frac{P(s)}{Q(s)} = \frac{A_1}{s - a_1} + \frac{A_2}{s - a_2} + \dots + \frac{A_n}{s - a_n} \quad (5.8)$$

where $A_1; A_2, \dots, A_n$, and a_1, a_2, \dots, a_n are constants to be determined by comparing coefficients of terms on both sides of the equality:

$$\frac{P(s)}{Q(s)} = \frac{A_1}{s - a_1} + \frac{A_2}{s - a_2} + \dots + \frac{A_n}{s - a_n}$$

- The inverse Laplace transform of $F(s) = P(s)/Q(s)$ becomes:

$$L^{-1}[F(s)] = L^{-1}\left[\frac{P(s)}{Q(s)}\right] = L^{-1}\left(\frac{A_1}{s - a_1}\right) + L^{-1}\left(\frac{A_2}{s - a_2}\right) + \dots + L^{-1}\left(\frac{A_n}{s - a_n}\right)$$

↑
←

Inverse LT of a fraction function = The sum of the Inverse LT of individual fractions of the function by partial fractions
9

Example 5.7:

Perform the inverse Laplace transform of the function:

$$F(s) = \frac{P(s)}{Q(s)} = \frac{3s + 7}{s^2 - 2s - 3}$$

Solution:

We may express $F(s)$ in the following partial fraction form:

$$F(s) = \frac{3s + 7}{s^2 - 2s - 3} = \frac{3s + 7}{(s - 3)(s + 1)} = \frac{A}{s - 3} + \frac{B}{s + 1} = \frac{A(s + 1) + B(s - 3)}{(s - 3)(s + 1)}$$

where A and B are constant coefficients

After expanding the above rational function and equating the terms in numerator:

$$3s + 7 = A(s + 1) + B(s - 3) = (A + B)s + (A - 3B)$$

We may solve for A and B from the simultaneous equations:

$$A + B = 3 \quad \text{and} \quad A - 3B = 7 \quad \text{yield} \quad A = 4 \quad \text{and} \quad B = -1$$

Thus we have:

$$\frac{3s + 7}{s^2 - 2s - 3} = \frac{4}{s - 3} - \frac{1}{s + 1}$$

The required Laplace transform is:

$$L^{-1}\left[\frac{3s + 7}{(s - 3)(s + 1)}\right] = 4L^{-1}\left(\frac{1}{s - 3}\right) - L^{-1}\left(\frac{1}{s + 1}\right) = 4e^{3t} - e^{-t}$$

Example 5.8:

Perform the inverse Laplace transform:

$$L^{-1}[F(s)] = L^{-1}\left[\frac{P(s)}{Q(s)}\right] = L^{-1}\left[\frac{3s+1}{s^3-s^2+s-1}\right]$$

Solution:

We may break up $F(s)$ in the above expression in the form:

$$\frac{P(s)}{Q(s)} = \frac{3s+1}{(s-1)(s^2+1)} = \frac{A}{s-1} + \frac{Bs+C}{s^2+1}$$

The polynomial in numerator is always one order less than in the denominator

By following the same procedure, we have coefficients $A = 2$, $B = -2$ and $C = 1$, or:

$$\frac{3s+1}{(s-1)(s^2+1)} = \frac{2}{s-1} - \frac{2s}{s^2+1} + \frac{1}{s^2+1}$$

We will thus have the inversed Laplace transform function $f(t)$ to be:

$$f(t) = L^{-1}[F(s)] = L^{-1}\left[\frac{3s+1}{s^3-s^2+s-1}\right] = L^{-1}\left(\frac{2}{s-1}\right) - L^{-1}\left(\frac{2s}{s^2+1}\right) + L^{-1}\left(\frac{1}{s^2+1}\right) = 2e^t - 2\cos t + \sin t$$

Inverse Laplace Transform by Convolution Theorem (P.151)

- This method involves the use of integration of expressions involving LT parameter s - $F(s)$
- There is no restriction on the form of the expression of s – they can be rational functions, or trigonometric functions or exponential functions
- The convolution theorem works in the following way for inverse Laplace transform:

If we know the following:

$$L^{-1}[F(s)] = f(t) \text{ and } L^{-1}[G(s)] = g(t), \text{ with } F(s) = \int_0^{\infty} e^{-st} f(t) dt \text{ and } G(s) = \int_0^{\infty} e^{-st} g(t) dt$$

most likely from the LP Table

Then the desired inverse Laplace transformed: $Q(s) = F(s) G(s)$ can be obtained by the following integrals:

$$L^{-1}[Q(s)] = L^{-1}[F(s)G(s)] = \int_0^t f(\tau) g(t - \tau) d\tau \quad (5.9)$$

OR

$$L^{-1}[Q(s)] = L^{-1}[F(s)G(s)] = \int_0^t f(t - \tau) g(\tau) d\tau \quad (5.10)$$

Example 5.9:

Find the inverse of a Laplace transformed function with: $Q(s) = \frac{s}{(s^2 + a^2)^2}$

Solution:

We may express F(s) in the following expression:

$$Q(s) = \frac{s}{(s^2 + a^2)^2} = \frac{s}{s^2 + a^2} \cdot \frac{1}{s^2 + a^2}$$

It is our choice to select F(s) and G(s) from the above expression for the integrals in Equation (5.9) or (5.10).

Let us choose: $F(s) = \frac{s}{s^2 + a^2}$ and $G(s) = \frac{1}{s^2 + a^2}$

From the LT Table, we have the following:

$$L^{-1}[F(s)] = \text{Cos}(at) = f(t) \quad \text{and} \quad L^{-1}[G(s)] = \frac{\text{Sin}(at)}{a} = g(t)$$

The inverse of Q(s) = F(s)G(s) is obtained by Equation (5.9) as:

$$L^{-1}\left[\frac{s}{(s^2 + a^2)^2}\right] = \int_0^t \text{Cos}a\tau \frac{\text{Sin}a(t - \tau)}{a} d\tau = \frac{t \text{Sin}at}{2a}$$

One will get the same result by using another convolution integral in Equation (5.10), or using partial fraction method in Equation (5.8)

Example 5.11:

Use convolution theorem to find the inverse Laplace transform: $Q(s) = \frac{1}{(s+1)(s^2+4)}$

We may express $Q(s)$ in the following form:

$$Q(s) = \frac{1}{(s+1)(s^2+4)} = \frac{1}{s+1} \cdot \frac{1}{s^2+4} \quad (a)$$

We choose $F(s)$ and $G(s)$ as:

$$F(s) = \frac{1}{s+1} \text{ or } e^{-t} = f(t) \quad \text{and} \quad G(s) = \frac{1}{s^2+4} \text{ or } \frac{1}{2} \sin 2t = g(t)$$

Let us use Equation (5.10) for the inverse of $Q(s)$ in Equation (a):

$$q(t) = \int_0^t f(t-\tau) g(\tau) d\tau = \int_0^t e^{-(t-\tau)} \left(\frac{1}{2} \sin 2\tau \right) d\tau = \frac{1}{2} e^{-t} \int_0^t e^{\tau} \sin 2\tau d\tau$$

After the integration, we get the inverse of Laplace transform $Q(s)$ to be:

$$q(t) = \frac{1}{2} e^{-t} \left[\frac{e^{\tau} (\sin 2\tau - 2 \cos 2\tau)}{1+2^2} \right]_0^t = \frac{1}{10} \sin 2t - \frac{1}{5} \cos 2t + \frac{1}{5} e^{-t}$$

Laplace Transform of Derivatives (P.153)

- We have learned the Laplace transform of function $f(t)$ by:

$$L_t[f(t)] = \int_0^{\infty} e^{-st} f(t) dt = F(s) \quad (5.1)$$

We realize the derivative of function $f(t)$: $f'(t) = \frac{df(t)}{dt}$ is also a **FUNCTION**

So, there should be a possible way to perform the Laplace transform of the derivatives of functions, as long as its variable varies from zero to infinity.

- Laplace transform of derivatives is necessary steps in solving DEs using Laplace transform
- By following the mathematical expression for Laplace transform of functions shown in Equation (5.1), we have:

$$L[f'(t)] = \int_0^{\infty} e^{-st} f'(t) dt = \int_0^{\infty} e^{-st} \left[\frac{df(t)}{dt} \right] dt \quad (5.11)$$

Let: $\int_0^{\infty} u dv = uv \Big|_0^{\infty} - \int_0^{\infty} v du$

The above integration in Equation (5.11) can be performed by “Integration-by-parts:”

If we let:

$$u = e^{-st} \quad \text{and} \quad dv = \left[\frac{df(t)}{dt} \right]$$

$$\downarrow \qquad \qquad \qquad \downarrow$$

$$du = -s e^{-st} dt \qquad \qquad \qquad v = f(t)$$

By substituting the above ‘u’, “du”, “dv” and “v” into the following:

$$L[f'(t)] = \int_0^{\infty} e^{-st} f'(t) dt = \int_0^{\infty} e^{-st} \left[\frac{df(t)}{dt} \right] dt \quad (5.11)$$

$$\int_0^{\infty} u dv = uv \Big|_0^{\infty} - \int_0^{\infty} v du$$

We will have:

$$L[f'(t)] = \int_0^{\infty} e^{-st} f'(t) dt = \int_0^{\infty} e^{-st} \left[\frac{df(t)}{dt} \right] dt = e^{-st} f(t) \Big|_0^{\infty} - \int_0^{\infty} f(t) (-se^{-st}) dt$$

leading to:

$$L[f'(t)] = \int_0^{\infty} e^{-st} f'(t) dt = e^{-st} f(t) \Big|_0^{\infty} - \int_0^{\infty} f(t) (-se^{-st}) dt = -f(0) + s \int_0^{\infty} e^{-st} f(t) dt = -f(0) + sL[f(t)]$$

or in a simplified form:

$$L[f'(t)] = s L[f(t)] - f(0) \quad (5.12)$$

- Likewise, we may find the Laplace transform of **second order derivative** of function f(t) to be:

$$L[f''(t)] = s^2 L[f(t)] - sf(0) - f'(0) \quad (5.13)$$

- A recurrence relation for Laplace transform of higher order (n) derivatives of function f(t) may be expressed as:

$$L[f^n(t)] = s^n L[f(t)] - s^{n-1} f(0) - s^{n-2} f'(0) - s^{n-3} f''(0) - \dots - f^{(n-1)}(0) \quad (5.14)$$

Example 5.12:

Find the Laplace transform of the **second order derivative** of function: $f(t) = t \text{Sint}$

The second order of derivative of $f(t)$ meaning $n = 2$ in Equation (5.14), or as in Equation (5.13):

$$L[f''(t)] = s^2 L[f(t)] - sf(0) - f'(0) \quad (5.13)$$

We thus have:

$$L\left[\frac{d^2 f(t)}{dt^2}\right] = s^2 L[f(t)] - sf(0) - f'(0)$$

Since

$$f'(t) = \frac{df(t)}{dt} = \frac{d(t \text{Sint})}{dt} = t \text{Cost} + \text{Sint}$$

We thus have:

$$\begin{aligned} L[f''(t)] &= s^2 L[f(t)] - s f(0) - f'(0) = s^2 L[t \text{Sint}] - s(t \text{Sint})\big|_{t=0} - (t \text{Cost} + \text{Sint})\big|_{t=0} \\ &= s^2 L[t \text{Sint}] \end{aligned}$$

Solution of DEs Using Laplace Transform (P.155)

- One popular application of Laplace transform is solving differential equations
- However, **such application MUST satisfy the following two conditions:**
 - The variable(s) in the function for the solution, e.g., x, y, z, t must cover the range of $(0, \infty)$.
That means the solution function, e.g., $u(x)$ or $u(t)$ MUST also be VALID for the range of $(0, \infty)$
 - ALL appropriate conditions for the differential equation MUST be available
- The solution procedure is as follows:

- (1) Apply Laplace transform on EVERY term in the DE
- (2) The Laplace transform of derivatives results in given conditions, such as $f(0)$, $f'(0)$, $f''(0)$, etc. as shown in Equation (5.14)
- (3) After apply the given values of the given conditions as required in Step (2), we will get an ALGEBRAIC equation for $F(s)$ as defined in Equation (5.1):

$$L[f(t)] = \int_0^{\infty} e^{-st} f(t) dt = F(s) \quad (5.1)$$

- (4) We thus can obtain an expression for $F(s)$ from Step (3)
- (5) The solution of the DE is the inverse of Laplace transformed $F(s)$, i.e.,:
$$f(t) = L^{-1}[F(s)]$$

Example 5.13:

Solve the following DE with given conditions:

$$\frac{d^2 y(t)}{dt^2} + 2 \frac{dy(t)}{dt} + 5y(t) = e^{-t} \sin t \quad 0 \leq t \leq \infty \quad (\text{a})$$

where $y(0) = 0$ and $y'(0) = 1$ (b)

Solution:

(1) Apply Laplace transform to EVERY term in the DE:

$$L\left[\frac{d^2 y(t)}{dt^2}\right] + 2L\left[\frac{dy(t)}{dt}\right] + 5L[y(t)] = L[e^{-t} \sin t] \quad (\text{c})$$

where $L[y(t)] = \int_0^{\infty} y(t) e^{-st} dt = Y(s)$

Use Equation (5.12) and (5.13) in Equation (c) will result in:

$$\left[s^2 Y(s) - sy(0) - y'(0)\right] + 2[sY(s) - y(0)] + 5Y(s) = \frac{1}{(s+1)^2 + 1} = \frac{1}{s^2 + 2s + 2} \quad (\text{d})$$

(2) Apply the given conditions in Equation (b) in Equation (d)

$$\left[s^2 Y(s) - \overset{=0}{\nearrow} sy(0) - \overset{=1}{\nearrow} y'(0)\right] + 2[sY(s) - \overset{=0}{\nearrow} y(0)] + 5Y(s) = \frac{1}{(s+1)^2 + 1} = \frac{1}{s^2 + 2s + 2}$$

(3) We can obtain the expression:

$$Y(s) = \frac{s^2 + 2s + 3}{(s^2 + 2s + 2)(s^2 + 2s + 5)} \quad (e)$$

(4) The solution of the DE in Equation (a) is the inverse Laplace transform of $Y(s)$ in Equation (e), i.e. $y(t) = L^{-1}[Y(s)]$, or:

$$y(t) = L^{-1}[Y(s)] = L^{-1}\left[\frac{s^2 + 2s + 3}{(s^2 + 2s + 2)(s^2 + 2s + 5)}\right]$$

(5) The inverse Laplace transform of $Y(s)$ in Equation (e) is obtained by using either “Partial fraction method” or “convolution theorem.” The expression of $Y(s)$ can be shown in the following form by “Partial fractions:”

$$Y(s) = \frac{\frac{1}{3}}{s^2 + 2s + 2} + \frac{\frac{2}{3}}{s^2 + 2s + 5} = \frac{1}{3} \cdot \frac{1}{s^2 + 2s + 2} + \frac{2}{3} \cdot \frac{1}{s^2 + 2s + 5}$$

The inversion of $Y(s)$ in the above form is:

$$y(t) = L^{-1}[Y(s)] = \frac{1}{3} L^{-1}\left[\frac{1}{s^2 + 2s + 2}\right] + \frac{2}{3} L^{-1}\left[\frac{1}{s^2 + 2s + 5}\right] = \frac{1}{3} L^{-1}\left[\frac{1}{(s+1)^2 + 1}\right] + \frac{2}{3} L^{-1}\left[\frac{1}{(s+1)^2 + 4}\right]$$

Leading to the solution of the DE in Equation (a) to be:

$$y(t) = L^{-1}[Y(s)] = \frac{1}{3} e^{-t} \sin t + \frac{2}{3} \frac{1}{2} e^{-t} \sin 2t = \frac{1}{3} e^{-t} (\sin t + \sin 2t)$$

Chapter 6

Review of Fourier Series and Its Applications in Mechanical Engineering Analysis

CONDENSED VERSION

Chapter Learning Objectives:

- 1) Fourier series is a mathematical expression used to describe **PERIODICAL PHENOMENA** in real world
- 2) Learn how to derive Fourier series with the function that represents the one-period of a given periodical phenomenon
- 3) How Fourier series **CONVERGE** (in other words, how many terms in the “infinite series” are required in the Fourier series to “converge” to the values of the function that represents the value of the given Periodic Phenomenon.
- 4) How Fourier series converge the values of a given non-continuous, or piece-wise continuous functions in given periods

Periodic Physical Phenomena:



Motions of ponies

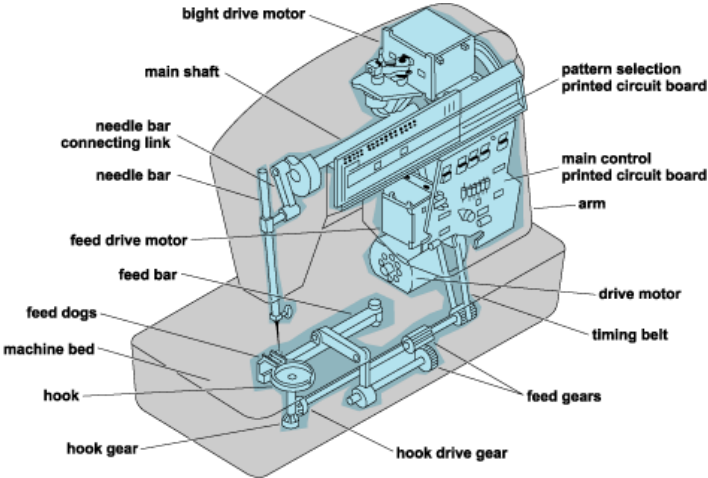

Forces on the needle

Machines with Periodic Physical Phenomena



A stamping machine involving cyclic punching of sheet metals

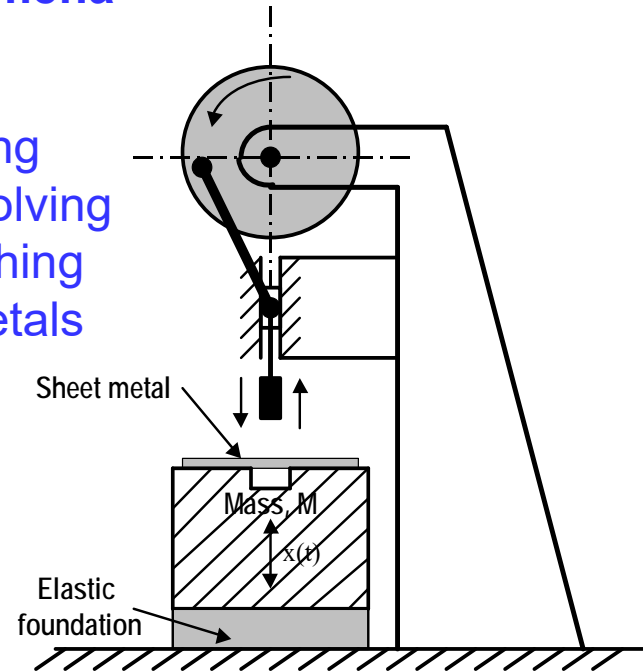

In a 4-stroke internal combustion engine:
Cyclic gas pressures on cylinders,
and forces on connecting rod and crank shaft

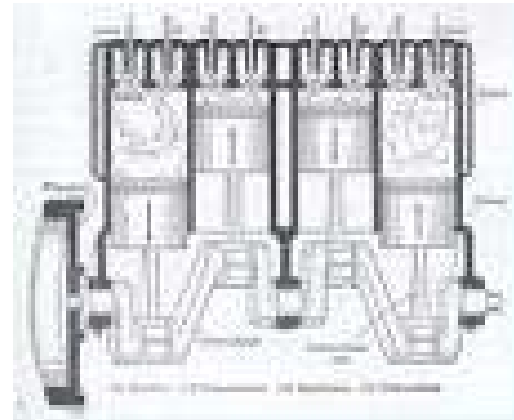

Mathematical expressions for periodical signals from an oscilloscope by Fourier series:

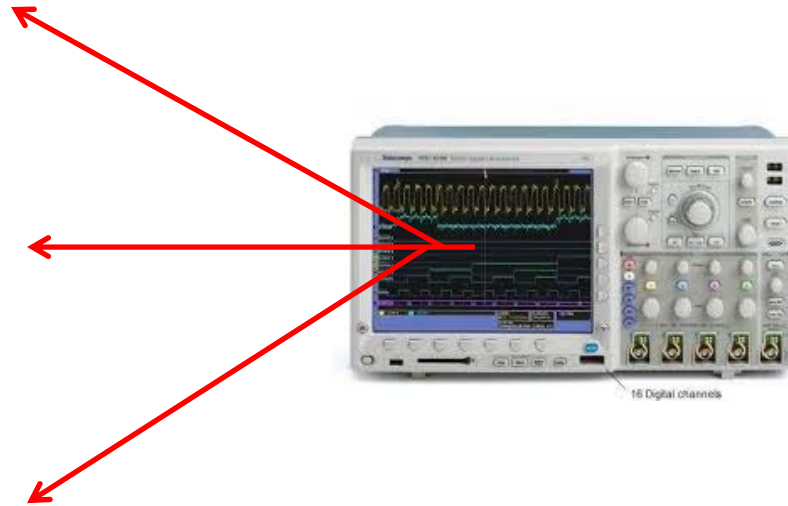

FOURIER SERIES – The mathematical representation of periodic physical phenomena

- Mathematical expression for periodic functions:
 - If $f(x)$ is a periodic function with variable x in **ONE period $2L$**
 - Then $f(x) = f(x \pm 2L) = f(x \pm 4L) = f(x \pm 6L) = f(x \pm 8L) = \dots = f(x \pm 2nL)$ where $n = \text{any integer number}$

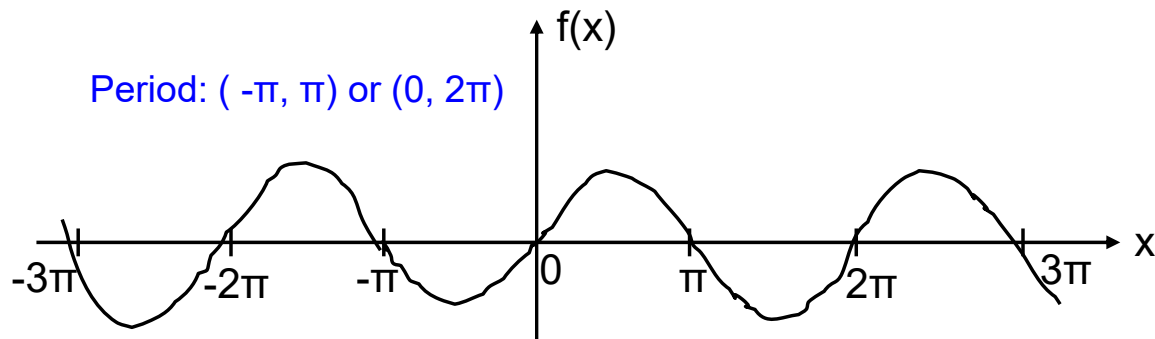

(a) Periodic function with period $(-\pi, \pi)$

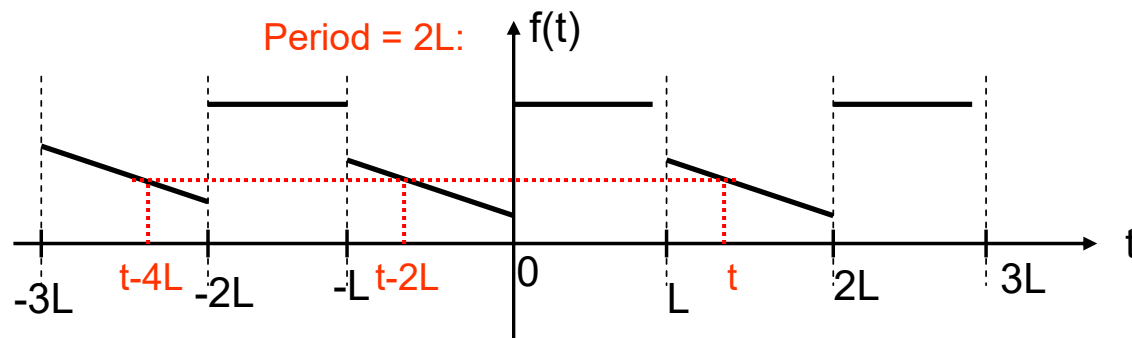

(b) Periodic function with period $(-L, L)$

Mathematical Expressions of Fourier Series (P.163)

- Required conditions for Fourier series:
 - The mathematical expression of the periodic function $f(x)$ in one period must be available
 - The function in one period is defined in an interval ($c < x < c+2L$) in which $c = 0$ or any arbitrarily chosen value of x , and $L =$ half period
 - The function $f(x)$ and its first order derivative $f'(x)$ are either continuous or piece-wise continuous in $c < x < c+2L$

- The mathematical expression of Fourier series for periodic function $f(x)$ is:

$$f(x) = \frac{a_0}{2} + \sum_{n=1}^{\infty} \left(a_n \cos \frac{n\pi x}{L} + b_n \sin \frac{n\pi x}{L} \right) = f(x \pm 2L) = f(x \pm 4L) = \dots \quad (6.1)$$

where a_0 , a_n and b_n are Fourier coefficients, to be determined by the following integrals:

$$a_n = \frac{1}{L} \int_c^{c+2L} f(x) \cos \frac{n\pi x}{L} dx \quad n = 0, 1, 2, 3, \dots \quad (6.2a)$$

$$b_n = \frac{1}{L} \int_c^{c+2L} f(x) \sin \frac{n\pi x}{L} dx \quad n = 1, 2, 3, \dots \quad (6.2b)$$

Examples 6.1-6.4 for continuous functions.
Examples 6.5 for piece-wise continuous function

Special Example (Problem 6.4 and Problem (3) of Final exam S09)

Derive a function describing the position of the sliding block M in one period in a slide mechanism as illustrated below. If the crank rotates at a constant velocity of 5 rpm.

- (a) Illustrate the periodic function in three periods, and
- (b) Derive the appropriate Fourier series describing the position of the sliding block $x(t)$ in which t is the time in minutes

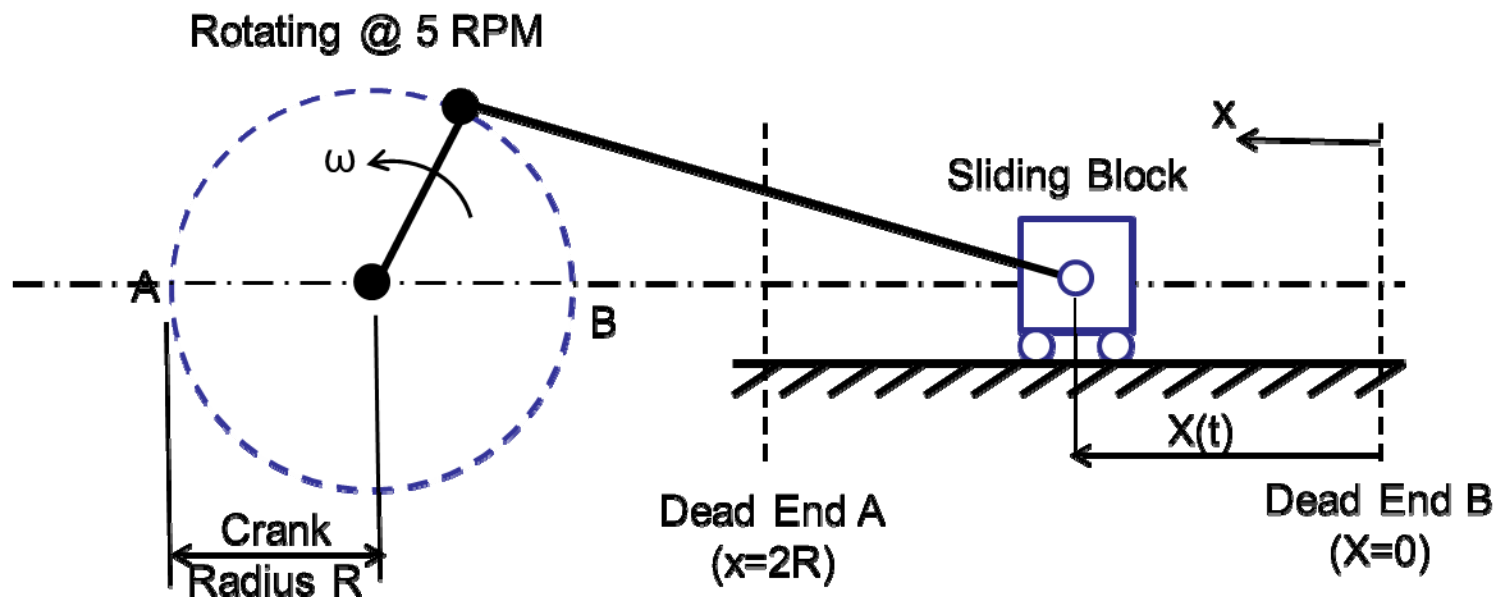

Solution:

(a) Illustrate the periodic function in three periods:

Determine the angular displacement of the crank:

We realize the relationship: 1 rev = 2π Rad, or 1 rpm = $2\pi/\text{min}$, N rpm = $2\pi N$ Rad/min, but $\theta = \omega t$, where ω = angular velocity, and θ = angular displacement relating to the position of the sliding block. Also, half rev. = $2R$ stroke of the sliding block.

For N = 5 rpm, we have: $\frac{\theta}{2\pi} = \frac{t}{\frac{1}{5}} = 5t$ Based on one revolution ($\theta = 2\pi$) corresponds to 1/5 min. We thus have $\theta = 10\pi t$

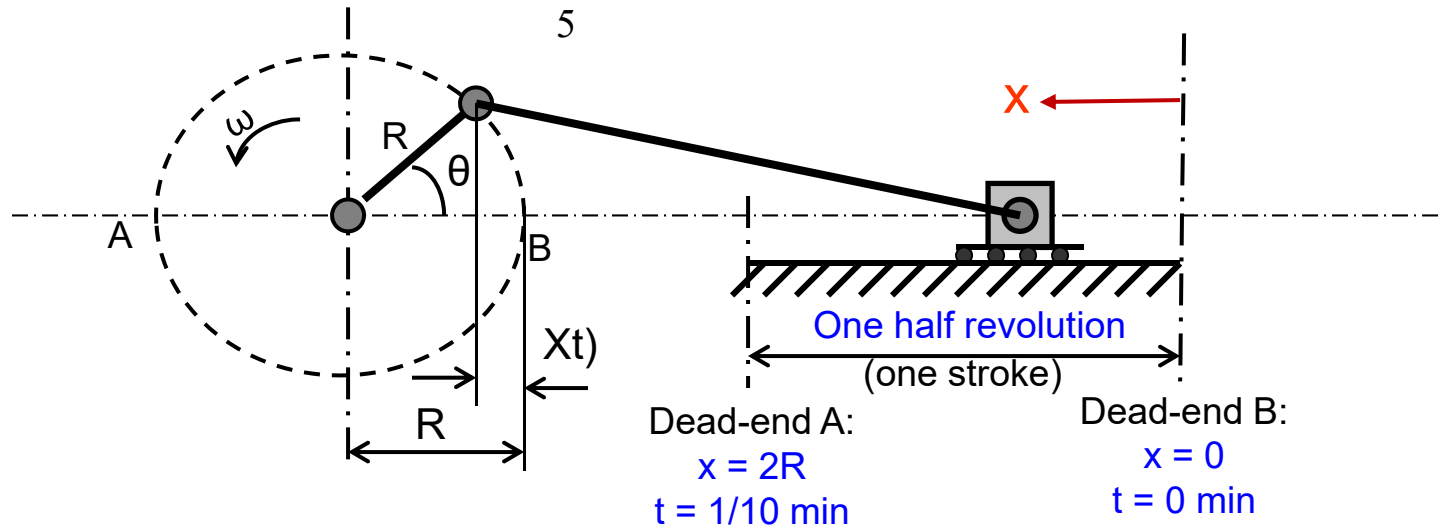

Position of the sliding block along the x-direction can be determined by:

$$x = R - R\cos\theta$$

or

$$x(t) = R - R\cos(10\pi t) = R[1 - \cos(10\pi t)] \quad 0 < t < 1/10 \text{ min}$$

STRONG Recommendation:
Make sure you know how to derive this function x(t) corresponding to the angular position of the crank!!

We have now derived the periodic function describing the instantaneous position of the sliding block as:

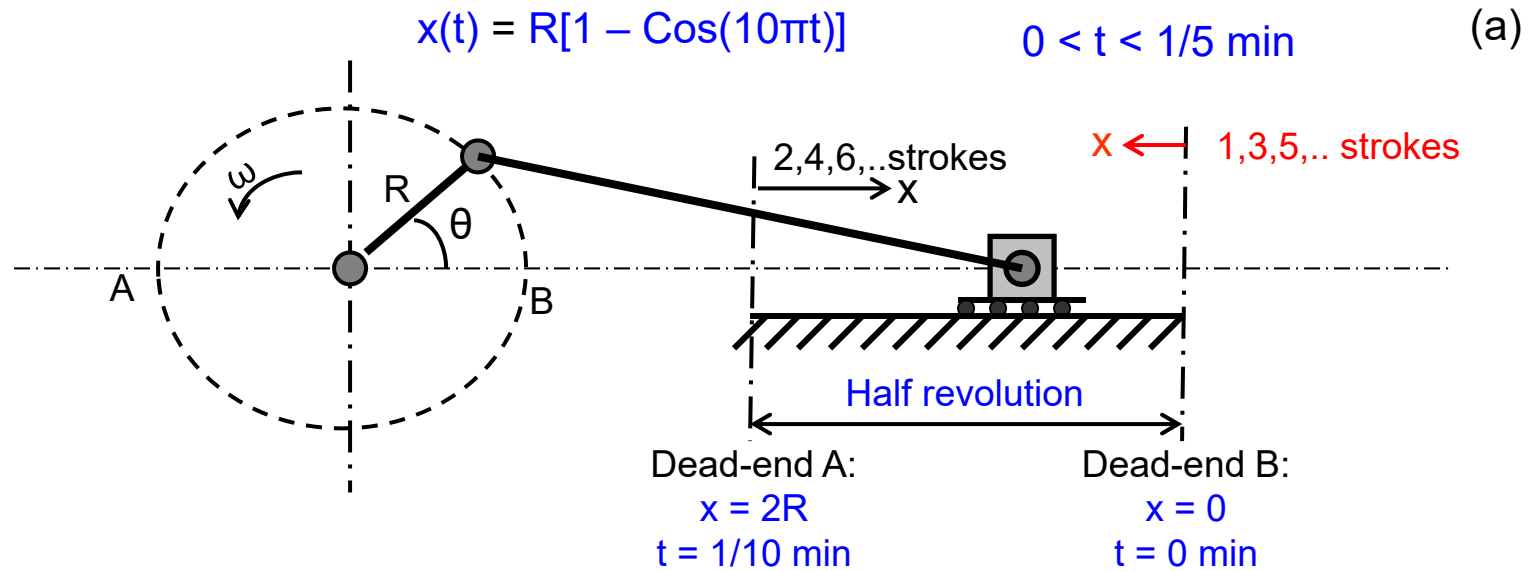

Graphical representation of function in Equation (a) can be produced as:

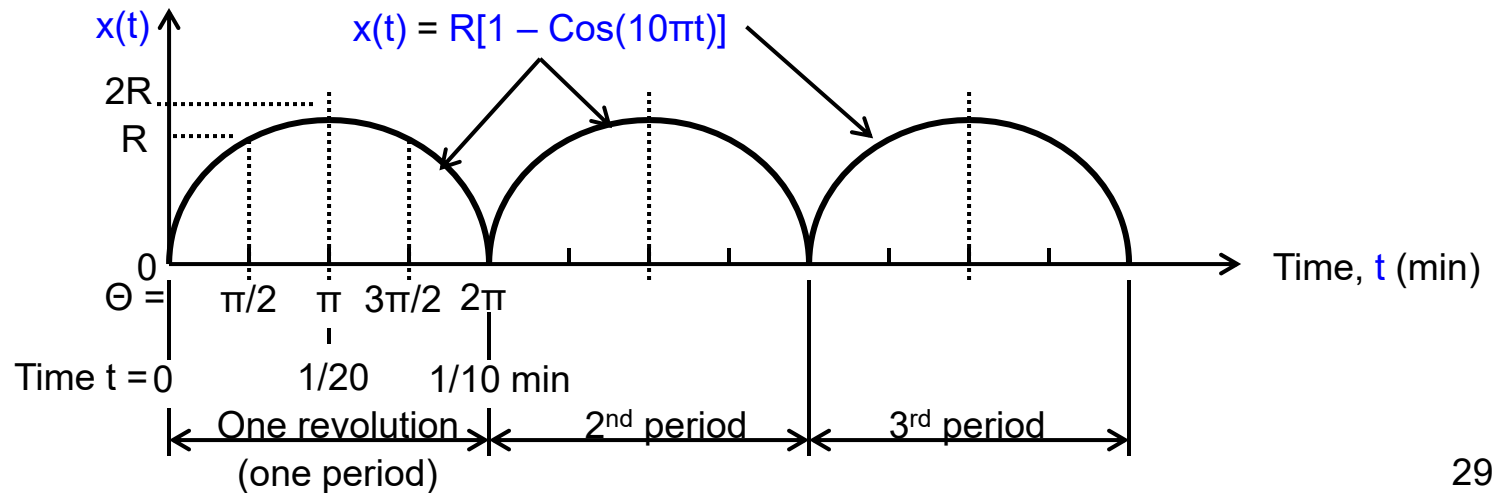

(b) Formulation of Fourier Series:

We have the periodic function: $x(t) = R[1 - \text{Cos}(10\pi t)]$ with a period: $0 < t < 1/10$ min

If we choose $c = 0$ and period $2L = 1/10$ ($L=1/20$), we will have the Fourier series expressed in the following forms by using Equations (6.1) and (6.2a,b):

$$\begin{aligned} x(t) &= \frac{a_o}{2} + \sum_{n=1}^{\infty} \left[a_n \text{Cos} \frac{n\pi t}{L = 1/20} + b_n \text{Sin} \frac{n\pi t}{L = 1/20} \right] \\ &= \frac{a_o}{2} + \sum_{n=1}^{\infty} [a_n \text{Cos} 20n\pi t + b_n \text{Sin} 20n\pi t] \end{aligned} \quad (b)$$

with

$$a_n = \frac{1}{1/20} \int_0^{1/10} x(t) \text{Cos} 20n\pi t dt \quad (c)$$

We may obtain coefficient a_o from Equation (c) to be $a_o = 0$:

The other coefficient b_n can be obtained by:

$$b_n = 20 \int_0^{1/10} x(t) \text{Sin} 20n\pi t dt = 20 \int_0^{1/10} R(1 - \text{Cos} 10\pi t) \text{Sin} 20n\pi t dt \quad (d)$$

Make sure that you know how to obtain the integrals in Equations (c) and (d)

Convergence of Fourier Series

We have learned the mathematical representation of periodic functions by Fourier series
In Equation (6.1):

$$f(x) = \frac{a_0}{2} + \sum_{n=1}^{\infty} \left(a_n \cos \frac{n\pi x}{L} + b_n \sin \frac{n\pi x}{L} \right) = f(x \pm 2L) = f(x \pm 4L) = \dots \quad (6.1)$$

This form requires the summation of “INFINITE” number of terms, which is UNREALISTIC.

The question is “HOW MANY” terms one needs to include in the summation in order to reach an accurate representation of the required periodic function [i.e., $f(x)$ in one period]?

The following example will give some idea on the relationship of the “number of terms in the Fourier series to represent the periodic function”:

Example 6.6

Derive the Fourier series for the following periodic function:

$$f(t) = \begin{cases} 0 & -\pi \leq t \leq 0 \\ \sin t & 0 \leq t \leq \pi \end{cases}$$

This function can be graphically represented as:

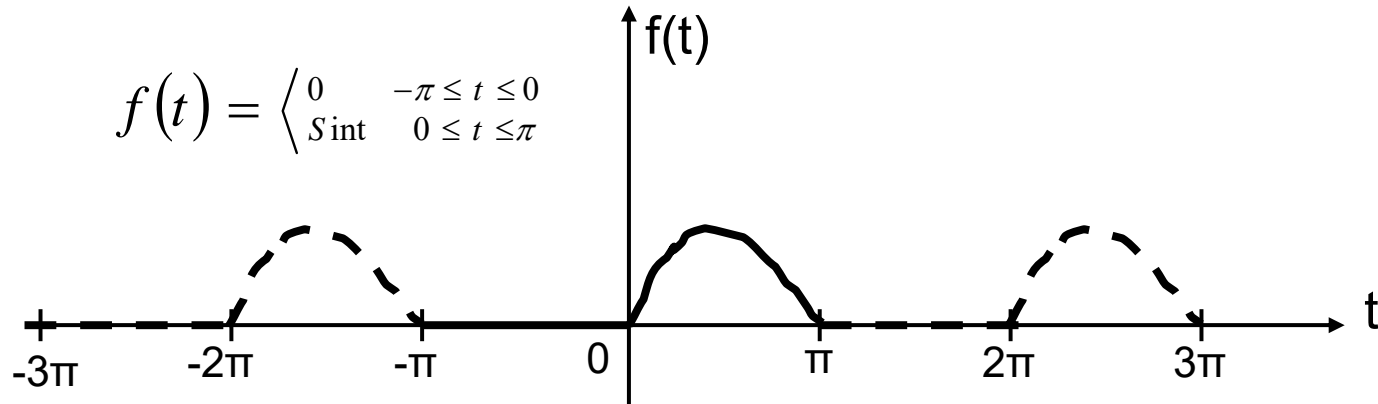

We identified the period to be: $2L = \pi - (-\pi) = 2\pi$, and from Equation (6.3), we have:

$$f(x) = \frac{a_0}{2} + \sum_{n=1}^{\infty} (a_n \text{Cos}(nx) + b_n \text{Sin}(nx)) \quad (\text{a})$$

with

$$a_n = \frac{1}{\pi} \int_{-\pi}^{\pi} f(t) \text{Cos}(nt) dt = \frac{1}{\pi} \int_{-\pi}^0 (0) \text{Cos} nt dt + \frac{1}{\pi} \int_0^{\pi} \text{Sint} \text{Cos} nt dt = \frac{1 + \text{Cos} n\pi}{(1 - n^2)\pi} \quad \text{for } n \neq 1 \quad (\text{b})$$

and

$$b_n = \frac{1}{\pi} \int_{-\pi}^{\pi} f(t) \text{Sin}(nt) dt = \frac{1}{\pi} \int_{-\pi}^0 (0) \text{Sin} nt dt + \frac{1}{\pi} \int_0^{\pi} \text{Sint} \text{Sin} nt dt \quad n = 1, 2, 3, \dots \quad (\text{c})$$

or

$$b_n = \frac{1}{\pi} \left\{ \frac{1}{2} \left[\frac{\text{Sin}(1-n)t}{1-n} - \frac{\text{Sin}(1+n)t}{1+n} \right] \right\} \Bigg|_0^{\pi} = 0 \quad \text{for } n \neq 1$$

For the case $n = 1$, the two coefficients become:

$$a_1 = \frac{1}{\pi} \int_0^{\pi} \text{Sint} \text{Cost} dt = \frac{\text{Sin}^2 t}{2\pi} \Bigg|_0^{\pi} = 0 \quad \text{and} \quad b_1 = \frac{1}{\pi} \int_0^{\pi} \text{Sint} \text{Sint} dt = \frac{1}{2}$$

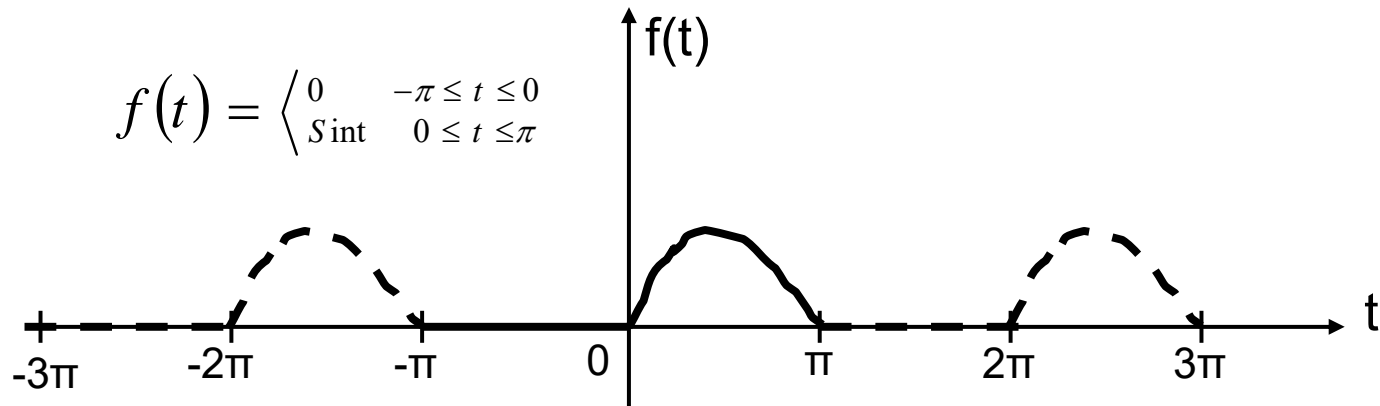

The Fourier series for the periodic function with the coefficients become:

$$f(t) = \frac{1}{\pi} + \frac{\text{Sint}}{2} + \sum_{n=2}^{\infty} (a_n \text{Cos } nt + b_n \text{Sin } nt) \quad (\text{d})$$

The Fourier series in Equation (b) can be expanded into the following infinite series:

$$f(t) = \frac{1}{\pi} + \frac{\text{Sint}}{2} - \frac{2}{\pi} \left(\frac{\text{Cos } 2t}{3} + \frac{\text{Cos } 4t}{15} + \frac{\text{Cos } 6t}{35} + \frac{\text{Cos } 8t}{63} + \dots \right) \quad (\text{e})$$

Let us now examine what the function would look like by including different number of terms in expression (c):

Case 1: Include only one term:

$$f(x) = f_1 = \frac{1}{\pi}$$

Graphically it will look like

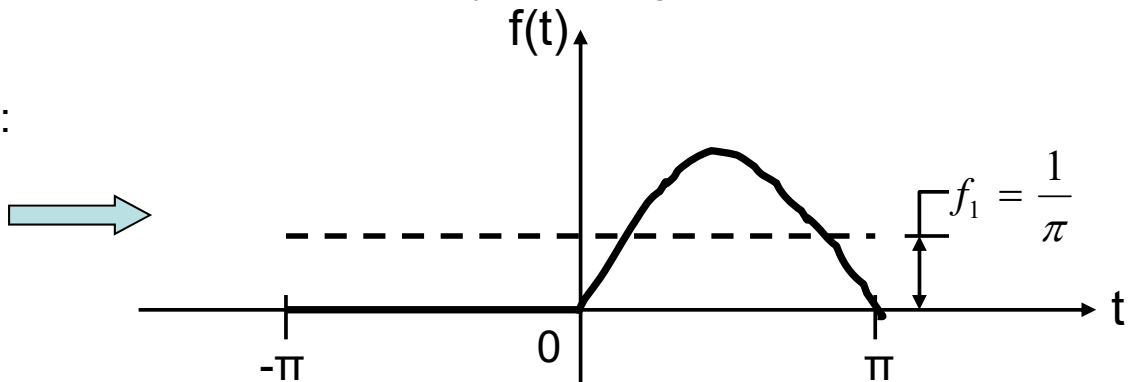

Observation: Not even closely resemble

- The Fourier series with one term does not converge to the function!

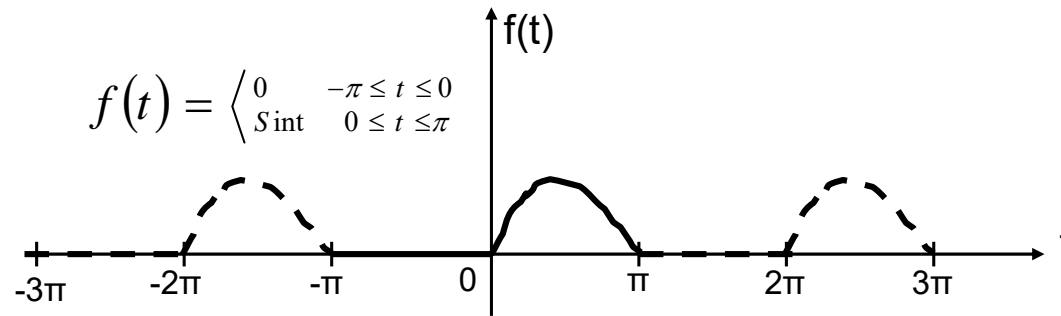

Case 2: Include 2 terms in Expression (b):

$$f(t) = f_2(t) = \frac{1}{\pi} + \frac{\text{Sint}}{2} \quad \Rightarrow$$

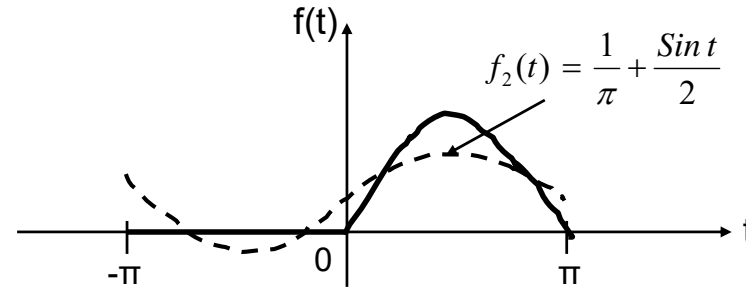

Observation: A Fourier series with 2 terms has shown improvement in representing the function

Case 3: Include 3 terms in Expression (b):

$$f(t) = f_3(t) = \frac{1}{\pi} + \frac{\text{Sint}}{2} - \frac{2\text{Cos } 2t}{3\pi} \quad \Rightarrow$$

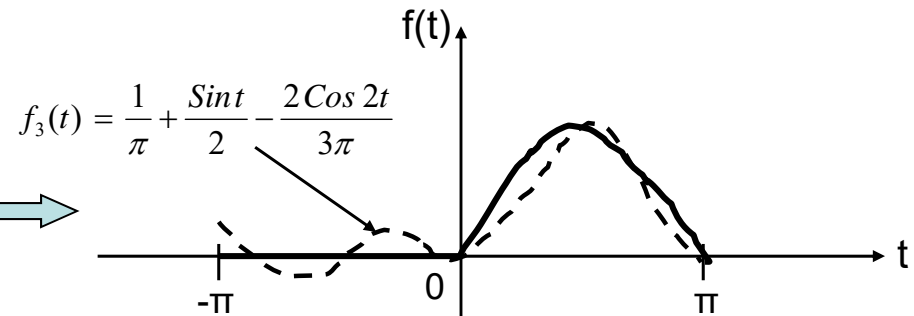

Observation: A Fourier series with 3 terms represent the function much better than the two previous cases with 1 and 2 terms.

Use four terms in Equation (e):

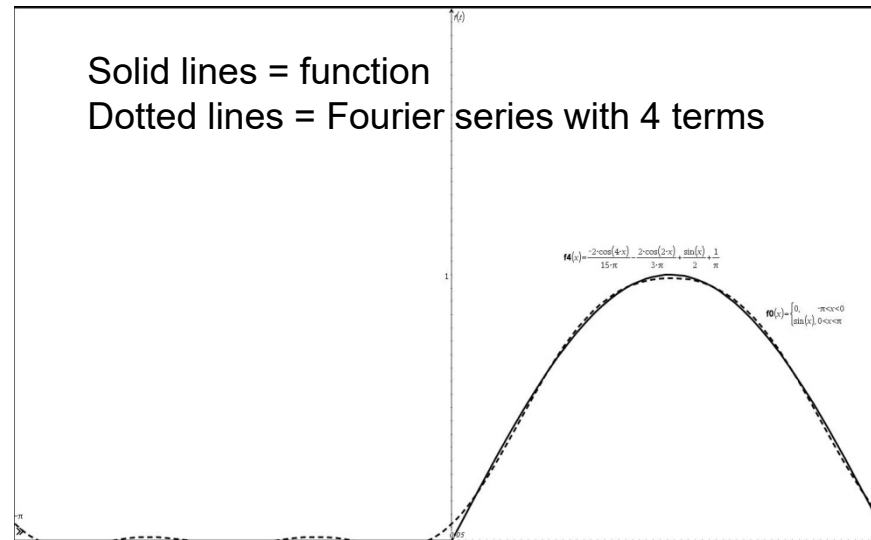

Conclusion: Fourier series converges better to the periodic function with more terms included in the series.

Practical consideration: It is not realistic to include infinite number of terms in the Fourier series for complete convergence. Normally an approach with 20 terms would be sufficiently accurate in representing most periodic functions

Convergence of Fourier Series at Discontinuities of Periodic Functions

Fourier series in Equations (6.1) to (6.3) converges to periodic functions everywhere except at discontinuities of piece-wise continuous function such as:

$$f(x) = \begin{cases} = f_1(x) & 0 < x < x_1 \\ = f_2(x) & x_1 < x < x_2 \\ = f_3(x) & x_2 < x < x_4 \end{cases}$$

The periodic function $f(x)$ has discontinuities at: x_0, x_1, x_2 and x_4

The Fourier series for this piece-wise continuous periodic function will NEVER converge at these discontinuous points even with ∞ number of terms

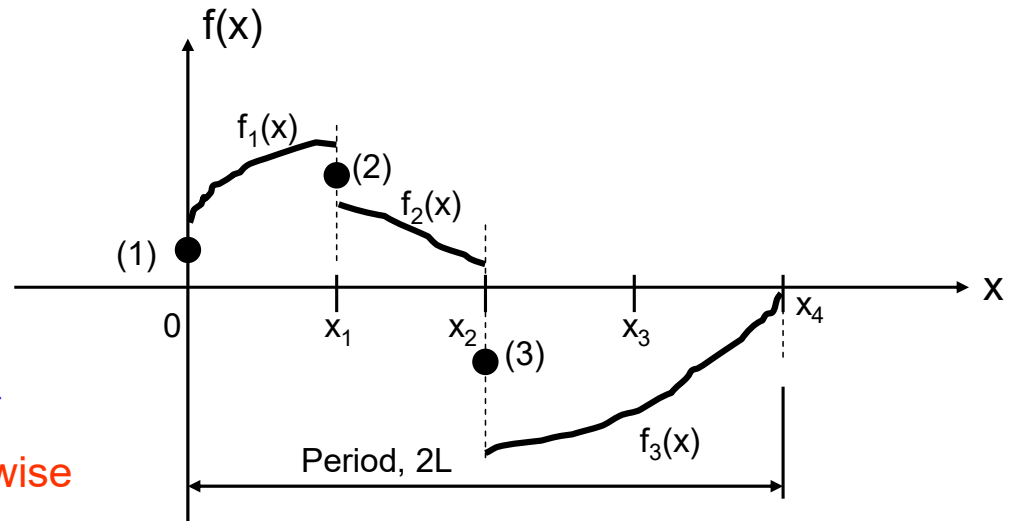

- The Fourier series in Equations (6.1), (6.2) and (6.3) will converge every where to the function except these discontinuities, at which the series will converge **HALF-WAY** of the function values at these discontinuities.

Convergence of Fourier Series at Discontinuities of Periodic Functions

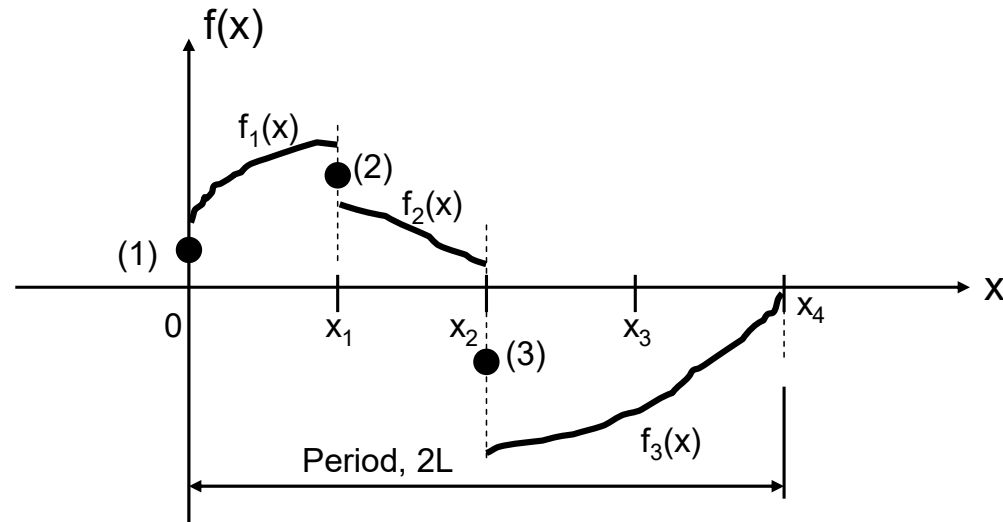

Convergence of Fourier series at HALF-WAY points:

$$f(0) = \frac{1}{2} f_1(0) \quad \text{at Point (1)}$$

$$f(x_1) = \frac{1}{2} [f_1(x_1) + f_2(x_1)] \quad \text{at Point (2)}$$

$$f(x_2) = \frac{1}{2} [f_2(x_2) + f_3(x_2)] \quad \text{at Point (3)}$$

$$f(x_4) = f_3(x_4) = \frac{1}{2} f_1(0) \quad \text{same value as Point (1)}$$

Example 6.8: convergence of Fourier series of piece-wise continuous function in one period:

The periodic function in one period:

$$f(t) = \begin{cases} 3t & (0 < t < 1) \\ 1.0 & (1 < t < 4) \end{cases}$$

The function has a period of 4
but is discontinuous at:
 $t = 1$ and $t = 4$

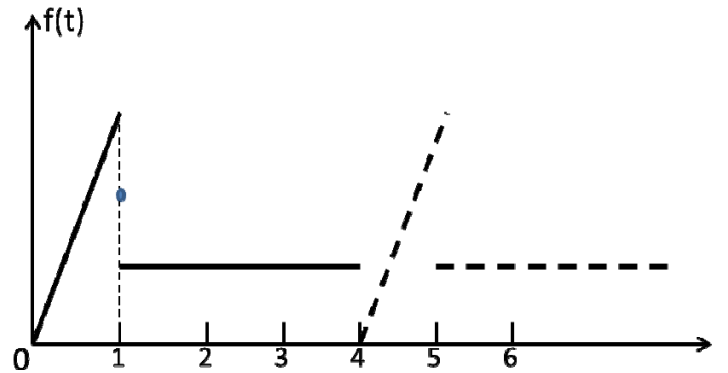

Derive the Fourier series to be:

$$f(t) = \frac{a_0}{2} + \sum_{n=1}^{\infty} \left(a_n \cos \frac{n\pi t}{L} + b_n \sin \frac{n\pi t}{L} \right)$$

with: $a_0 = \frac{15}{4}$

and $a_n = \frac{6}{n^2 \pi^2} \left(\cos \frac{n\pi}{2} - 1 \right) + \frac{1}{n^3 \pi^3} (12 - n^2 \pi^2) \sin \frac{n\pi}{2}$ with $n = 1, 2, 3, 4, 5, \dots$

$$b_n = \frac{6}{n^2 \pi^2} \sin \frac{n\pi}{2} - \frac{1}{n\pi} \left(4 \cos \frac{n\pi}{2} + \cos 2n\pi \right)$$
 with $n = 1, 2, 3, 4, 5, \dots$

Draw the curves represented by the above Fourier series with different number of terms to illustrate the convergence of the series:

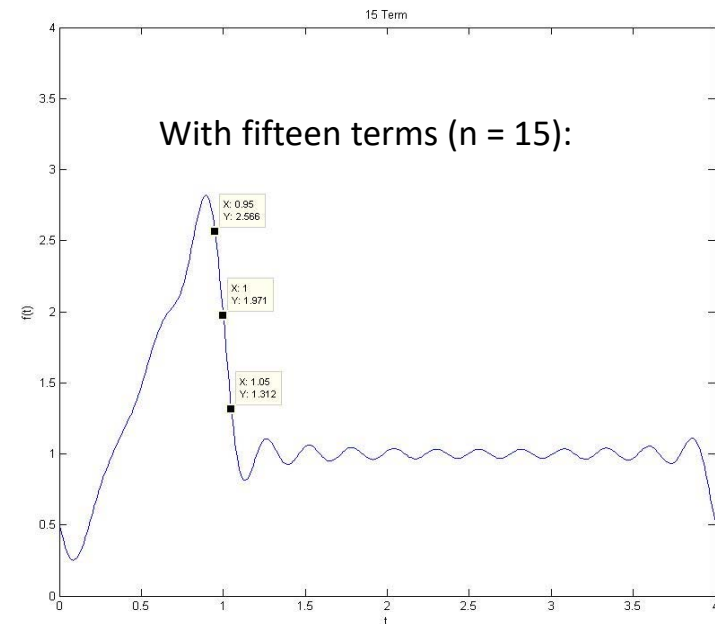
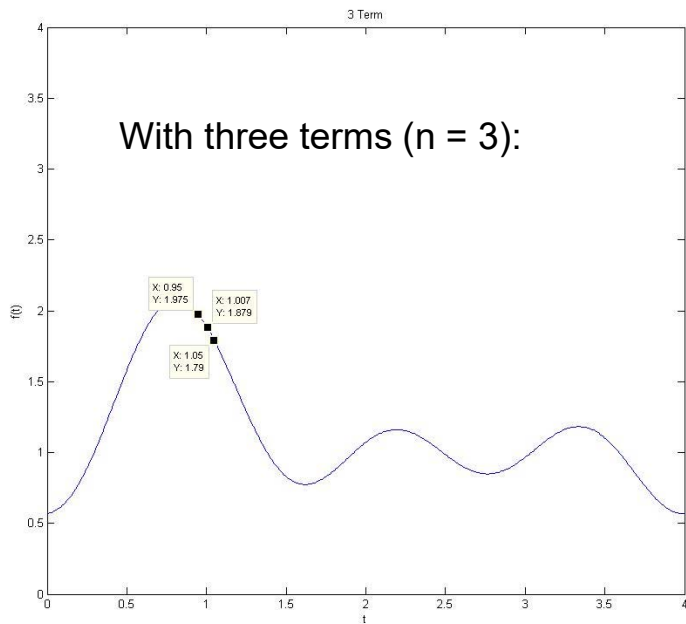

Converges well with 80 terms!!

Observe the convergence of
Fourier series at
DISCONTINUITIES

